



California Faucets®

# Huntington™

## SINGLE HOLE LAV / VESSEL / BAR FAUCET

### Features

- 4-9/16" spout center to center
- Single handle operation cartridge with ceramic disc
- Flexible braided hoses for ease of installation
- Flush mount aerator insert
- 1.2 gpm (4.5 L/min) max flow rate
- Solid brass construction
- Over 30 finishes including 15 PVD finishes

### Codes/Standards

Product meets or exceeds the following:

- ASME A112.18.1/CSA B125.1
- NSF/ANSI 61 & NSF/ANSI 372
- CEC
- EPA WaterSense High Efficiency Lavatory
- ADA compliant

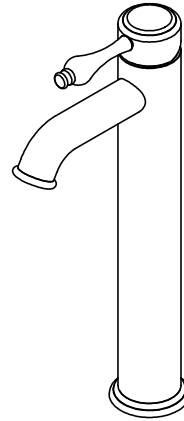

### CF-4201-2



### CF-4201-2-HXX (XX = Optional Series Handle)

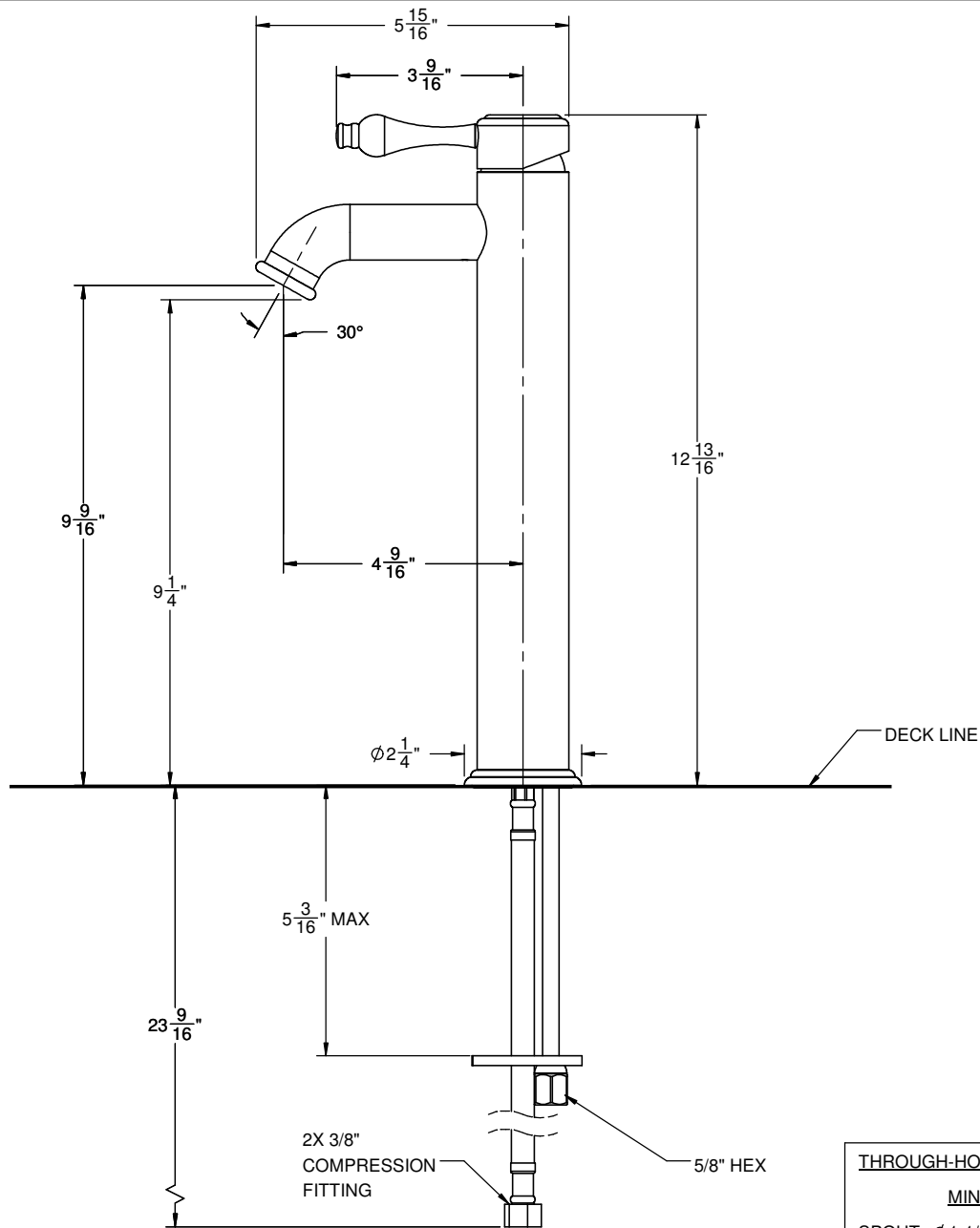

THROUGH-HOLE SPECIFICATIONS	
MIN	RECOMMENDED
SPOUT: $\phi$ 1-1/4"	$\phi$ 1-3/8"



California Faucets®

# Huntington™

## SINGLE HOLE LAV / VESSEL / BAR FAUCET

**CF-4201-2-H33**

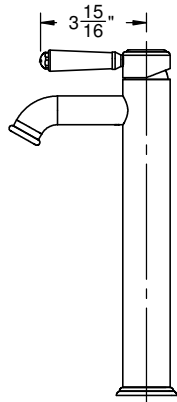
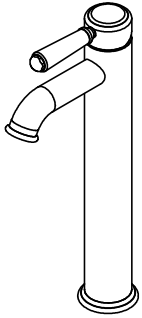

**CF-4201-2-H35**

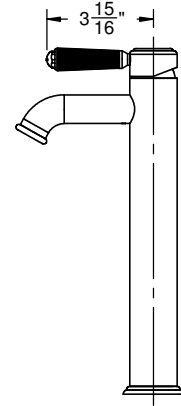
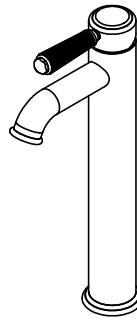

**CF-4201-2-H40**

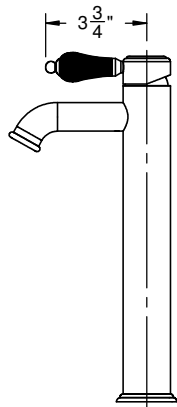
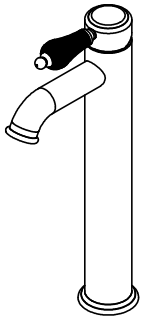

**CF-4201-2-H55**

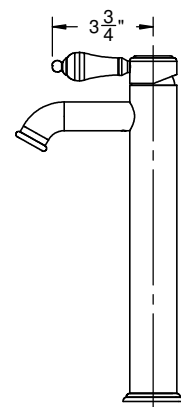
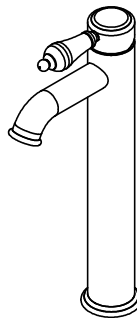

**CF-4201-2-H64**

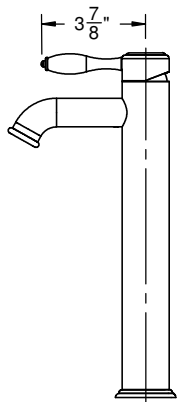
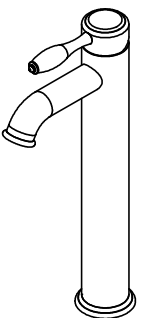

**CF-4201-2-H68**

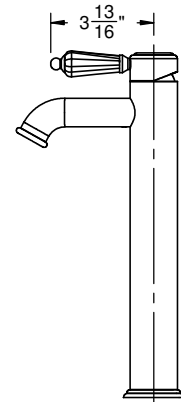
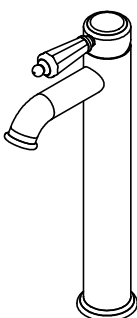

**CF-4201-2-CLEV**

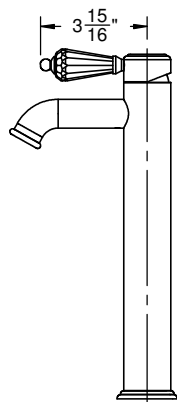
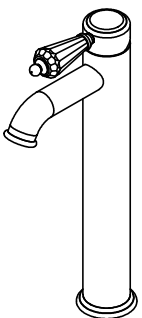

ALL DIMENSIONS SHOWN TO NEAREST 1/16"