

### 35-2.2-ED3

Wall Mounted 3 Hole Lavatory Set

Requires SS-THV2.2 concealed valve

Flow Rate: 1.2 GPM

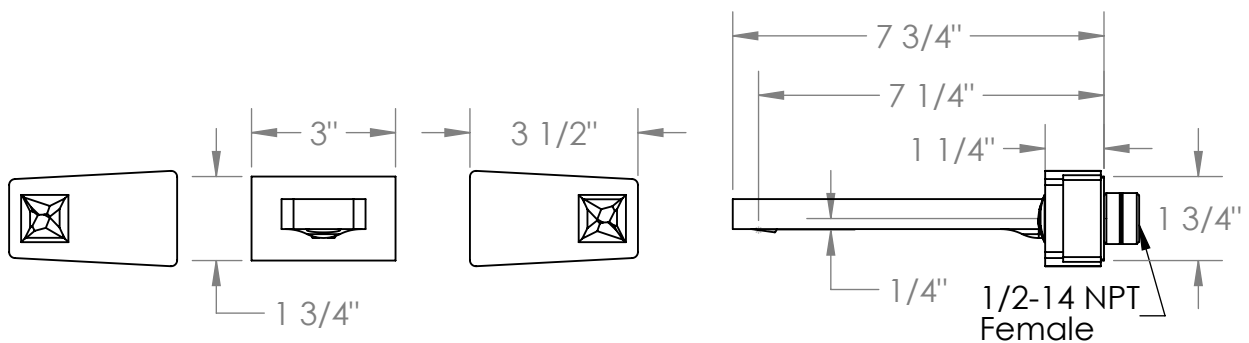
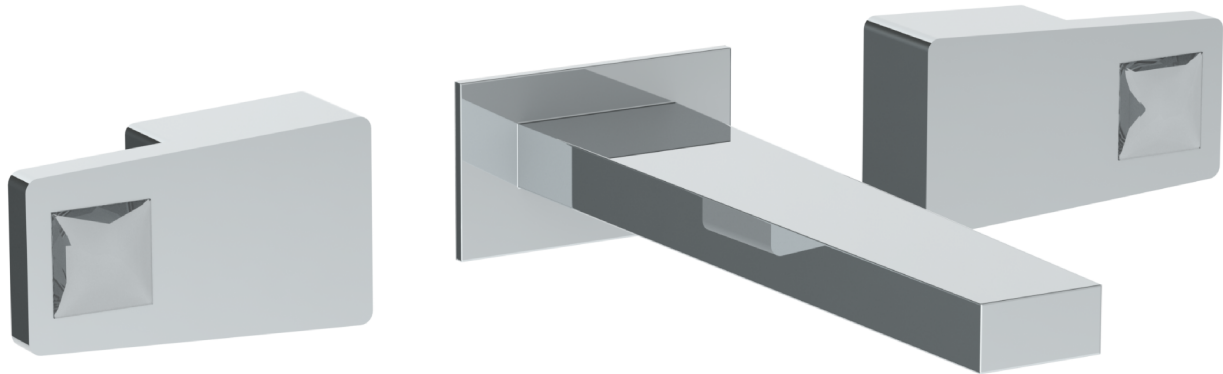

Meets the applicable requirements of ASME A112.18.1-2005/CSA B125.1-05, entitled "Plumbing Supply Fittings"

# **WATERMARK** DESIGNS 6/4/2020

350 Dewitt Ave Brooklyn NY 11207 USA T 718 257 2800 F 718 257 2144 info@watermark-designs.com