

CODE NUMBER

3782617

DESCRIPTION

1.0 gpf, Polished Chrome Finish, Single Flush, Battery, Sloan® Exposed Sensor Urinal Flushometer.

DETAILS

- Flush Volume: 1.0 gpf (3.8 Lpf)
- Finish: Polished Chrome (CP)
- Power Type: Battery
- Battery Life: 3 years
- Valve: Diaphragm
- Valve Body Material: Semi-red Brass
- Fixture Type: Urinal
- Fixture Connection: Top spud
- Rough-In Dimension: 11 ½" (292mm)
- Spud Coupling: ¾" (19mm)
- Supply Pipe: ¾" (19mm)

FEATURES

- Non-Hold-Open Handle, Fixed Metering Bypass and No External Volume Adjustment to Ensure Water Conservation
- Vacuum Breaker with Flush Connection
- Sweat Solder Adapter with Cover Tube and Cast Wall Flange
- Diaphragm, Handle Packing and Vacuum Breaker Molded from PERMEX® Rubber Compound for Chloramine Resistance
- ¾" I.P.S. Screwdriver Bak-Chek® Angle Stop with Vandal Resistant Stop Cap
- Spud Coupling and Spud Flange for ¾" Top Spud Optima SMOOTH Unit
- Sensor with Automatic Range Adjustment
- "User in View" Flashing LED
- "Low Battery" Flashing LED
- Mechanical Manual Override Flush Handle
- Four (4) Size C Batteries included
- ADA Compliant Metal Oscillating Non-Hold-Open Handle
- High Chloramine Resistant PERMEX® Synthetic Rubber Diaphragm with Linear Filtered Bypass and Vortex Cleansing Action™
- ADA Compliant OPTIMA® SMOOTH® Battery Powered Infrared Sensor for automatic "Hands-free" operation



COMPLIANCES & CERTIFICATIONS



(ADA Compliant, cUPC Certified, BAA Compliant)

RECOMMENDED SPECIFICATION

Valve Body, Cover, Tailpiece and Control Stop shall be in conformance with ASTM Alloy Classification for Semi- Red Brass. Valve shall be in compliance with the applicable sections of ASSE 1037 and ANSI/ASME 112.19.2.

ELECTRICAL SPECIFICATIONS

- Battery Life: 3 years

VALVE OPERATING PRESSURE (FLOWING)

PSI (0 kPa). Specific fixtures may require greater minimum flowing pressure - consult manufacturer requirements.

DOWNLOADS

- [Sloan Exposed Installation Instructions](#)
- [Sloan Exposed \(Spanish\) Installation Instructions](#)
- [EBV 200 Installation Instructions](#)
- [EL 600-A Installation Instructions](#)
- [Control Stop Repair and Maintenance Guide](#)
- [Flush Connections Flanges Repair and Maintenance Guide](#)
- [Tail Piece Repair and Maintenance Guide](#)
- [Sloan Flushometer Repair and Maintenance Guide](#)
- [Additional Downloads](#)

NOTES

All information contained within this document subject to change without notice.

Looking for other variations of the SLOAN 186 SMOOTH product? [View the general spec sheet with all options.](#)

[Find a compatible urinal](#) for this flushometer.

[Find a compatible water closet](#) for this flushometer.

Sloan 10500 Seymour Ave, Franklin Park, IL 60131

Phone: 800.982.5839 • Fax: 800.447.8329 • sloan.com

ROUGH-IN

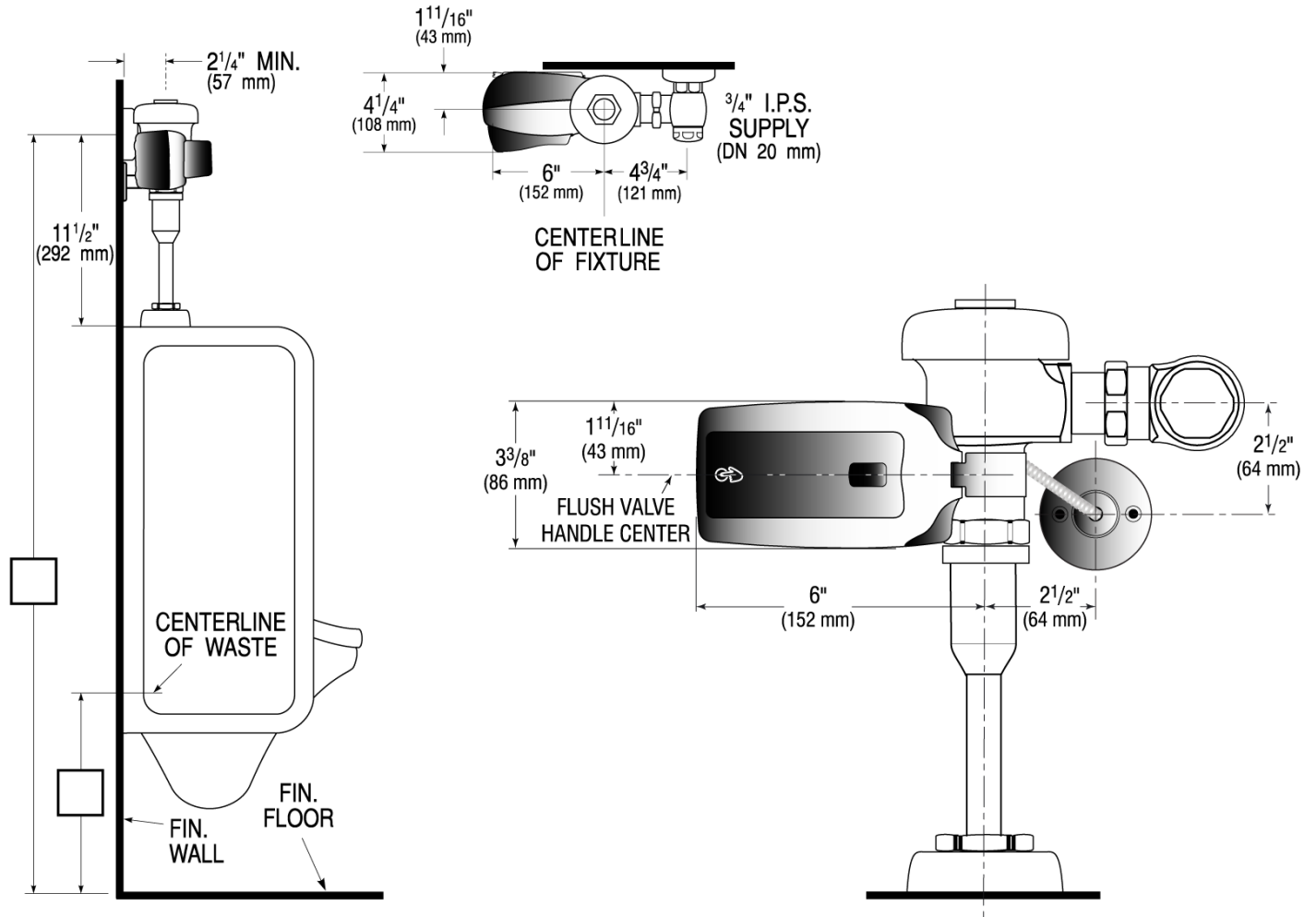

Sloan 10500 Seymour Ave, Franklin Park, IL 60131

Phone: 800.982.5839 • Fax: 800.447.8329 • sloan.com