

Features

- Color and style matched to Profiles styling suite.
- Quiet close Safeseal® Gasket
- Mirrored interior with 3 adjustable glass shelves
- Includes magnetic storage area
- Includes installation hardware for recess mounting
- Can be recessed or surface mounted (surface mounting kit required)
- Electric Option Cabinet:
 - Standard knock out for 1/2" (13 mm) cable connector
 - Wired internally - Front access serviceability
 - USB charging port

Construction

- Satin anodized aluminum body
- 3 mirror design - rear of cabinet and both sides of door
- Blum 170° self-closing hinges
- Safeseal® Gasket with sealed corners on cabinet body
- Adjustable shelving at 2" (51 mm) increments

Codes/Standards Applicable

- Electric Option Models are ETL certified to:
 - UL 962
 - CSA Standard C22.2 No. 68

Dimensions

Height: 30" (762 mm)
 Width: 23-1/4" (591 mm)
 Depth: 6-5/8" (168 mm) Surface, 15/16" (24 mm) Project from wall when recessed, and 3" (76 mm) Project from wall when semi-recessed

Options

- Left or Right hand hinged
- Electric includes two USB (3 amp max combined) and 120VAC outlet in Interior
- Other widths / heights / depths available

Installation Options

Recessed Mount - Rough Opening - 29-1/4" H x 22-1/2" W x 6" D (743 mm H x 572 mm W x 152 mm D)
Semi-Recessed Mount - Rough Opening - 29-1/4" H x 22-1/2" W x 4" D (743 mm H x 572 mm W x 102 mm D)
 Reference Surface Mount Kit when ordering
 MSMK30D6SRP - Plain Mirror Kit
 MSMK30D6SR## - Decorative Kit
Surface Mount - Reference Surface Mount Kit when ordering
 MSMK30D6P - Plain Mirror Kit
 MSMK30D6## - Decorative Kit
Gangs to Profiles Mirror - Reference Profiles Mirror Ganging Kit when ordering - PMGKIT
Gangs to M Series Cabinet - Reference M Ganging Kit when ordering - MGKIT
Gangs to M Series Lighting - Reference Ganging kit for the particular light option when ordering

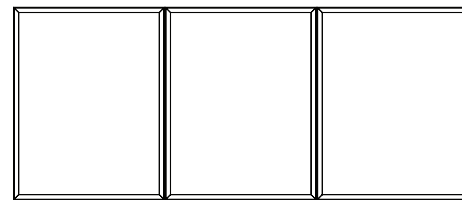
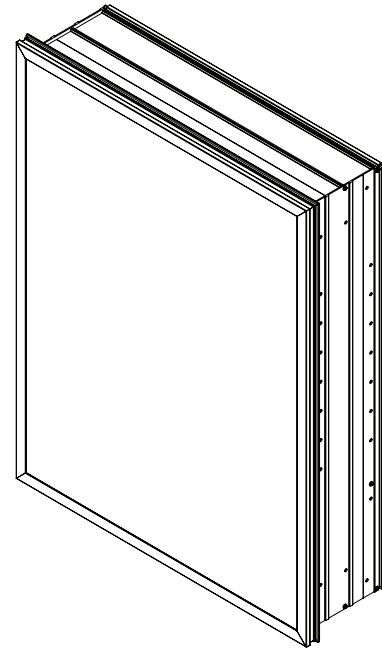

Example: Ganging Cabinet-to-Cabinet Arrangement

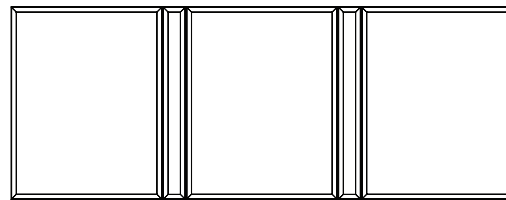

Example: Ganging Cabinet-to-Lights Arrangement

Model Number Key

Profiles	Cabinet	Width	Height	Depth	Frame Width	Hinge Location	Options	Metal Frame Finish
P	C	24	30	D6	T = 3/4"	L = Left R = Right N = Non-Handed	N = Non-Electric E = Electric	76 = Chrome 77 = Polished Nickel 82 = Matte Gold 83 = Matte Black

Electrical System

Electrical system requirement for electric option cabinets

- Source: 120 VAC 60HZ 20 GFI circuit
- Load: 120 VAC 15A max
- Field wire location as shown in drawing
- 1/2" conduit (Ø 7/8" actual) electrical knockout location shown below
- USB charging port

Optional Accessories

- Assorted glass bins:
 - Small (GLASSBIN3.25)
 - Medium (GLASSBIN5.25)
 - Large (GLASSBIN8.5)
- Pull-out Magnifying Mirror - POMM
- Push-to-open Kit - MPUSHKIT
- Safety Lock Box - SLB
- Swing out Magnifying Mirror - SOMM
- Razor/phone holder - MA-TRAY2.5
- 3 tier tray, 3 Inch - MA-TRAY3
- 3 tier tray, 5 Inch - MA-TRAY5

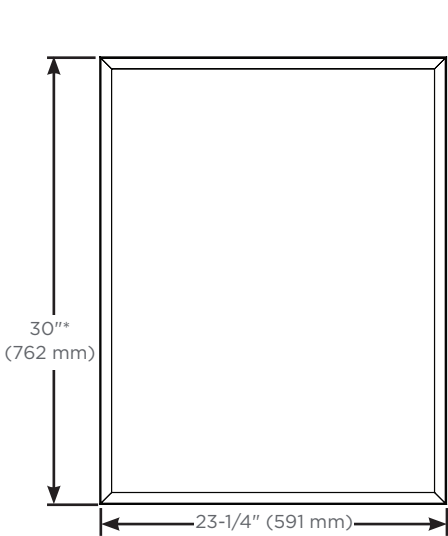
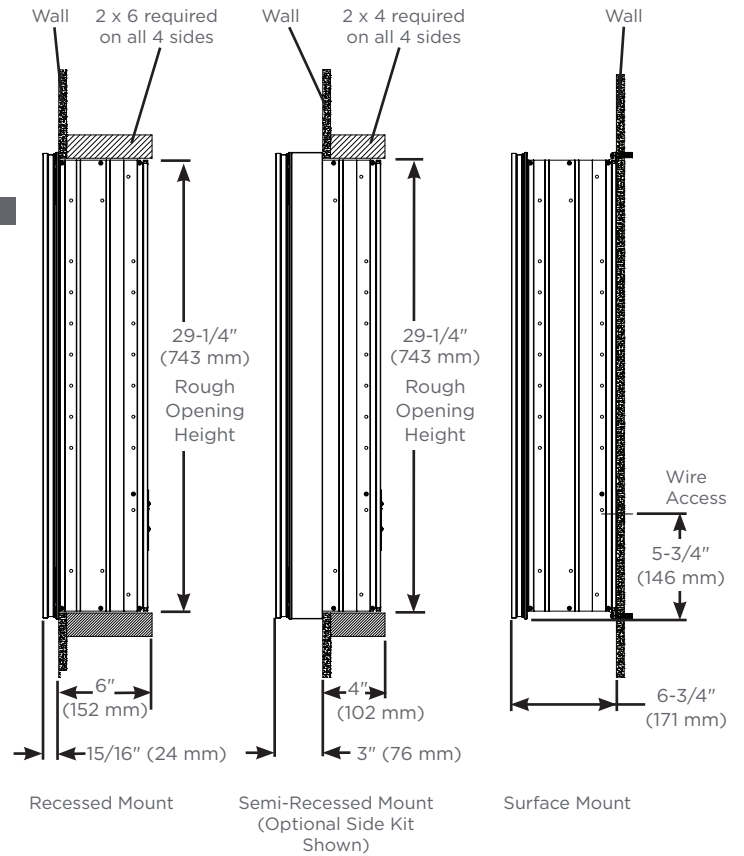

Cabinet Dimensions
 *Door is 1/8" (3 mm) smaller than cabinet

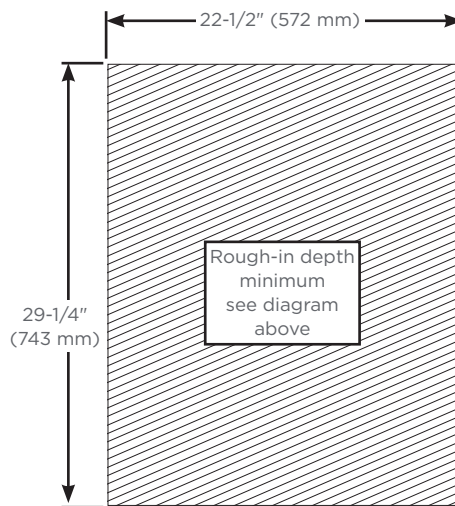

Rough-in Dimensions
 Recessed mount only

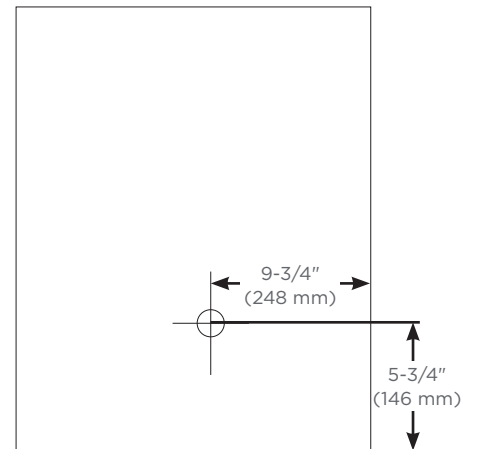

Back of Cabinet - Wire Access Location