

FLATIRON MUS-803SB

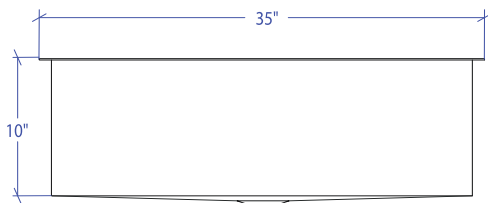

*Custom ADA compliant versions are available

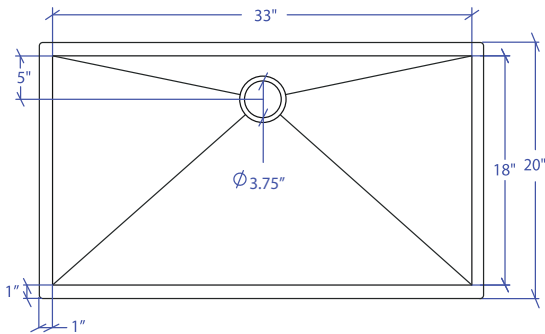

• FEATURES

16-gauge type 304 stainless steel
90° zero radius design

• TECHNICAL INFORMATION

External dimension: 35"Lx20"Wx10"D
Basin dimensions: 33"Lx18"Wx10"D

• FINISHES

Satin Brushed stainless steel

• INSTALLATION OPTIONS

Top-mount
Under-mount

• MINIMUM CABINET SIZE (I.D.)

Top-mount 36"
Under-mount 38"

• DUAL-MOUNT INSTALLATION

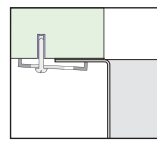

Under-mount

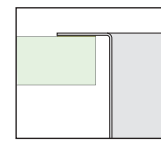

Top-mount

• ACCESSORY OPTIONS

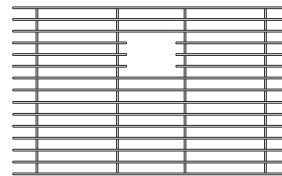

MBG-087SB
Basin Grid

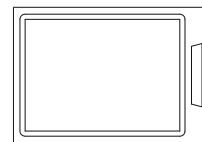

MCB-801BB
Cutting Board

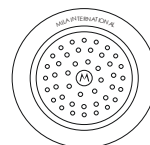

MKD-101SB
Strainer

PROJECT INFORMATION

Project			
Date	/ /	QTY	
Specifier			
Contact			
Note			