

FLATIRON MUS-301SB

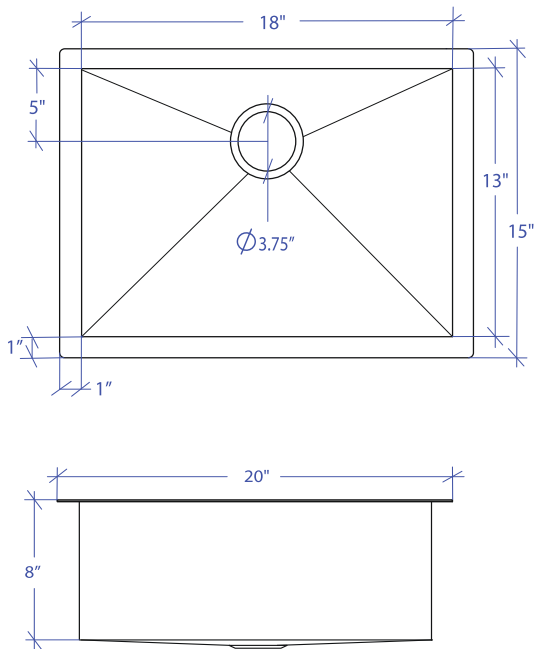

*Custom ADA compliant versions are available



• FEATURES

16-gauge type 304 stainless steel
90° zero radius design

• TECHNICAL INFORMATION

External dimension: 20"Lx15"Wx8"D
Basin dimensions: 18"Lx13"Wx8"D

• FINISHES

Satin Brushed stainless steel

• INSTALLATION OPTIONS

Top-mount
Under-mount

• MINIMUM CABINET SIZE (I.D.)

Top-mount 21"
Under-mount 23"

• DUAL-MOUNT INSTALLATION

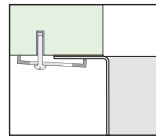

Under-mount

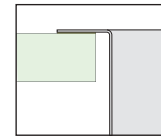

Top-mount

• ACCESSORY OPTIONS

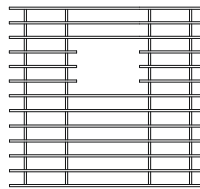

MBG-031SB
Basin Grid

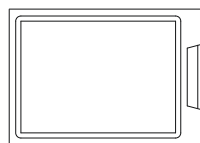

MCB-501BB
Cutting Board

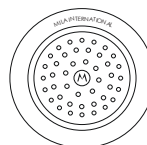

MKD-101SB
Strainer

PROJECT INFORMATION

Project			
Date	/ /	QTY	
Specifier			
Contact			
Note			