

ORION MOUS-805GDSB

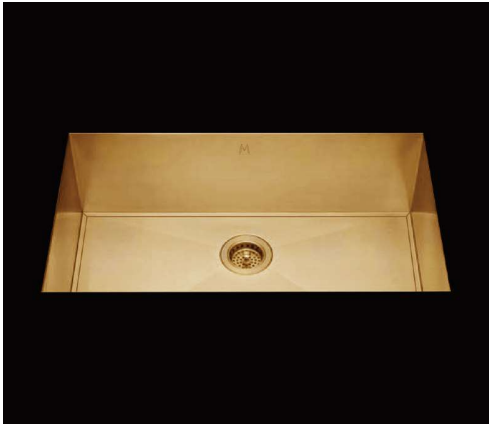

*Custom ADA compliant versions are available

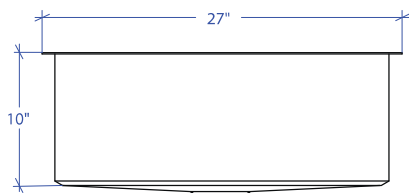
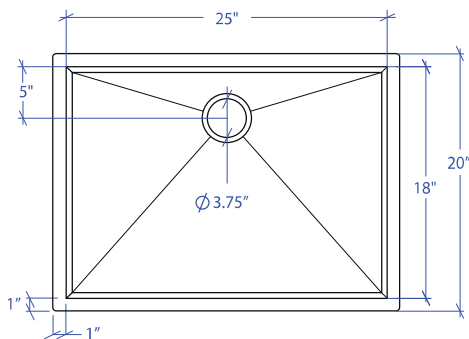

• FEATURES

16-gauge type 304 stainless steel
Bevel basin design

• TECHNICAL INFORMATION

External dimension: 27"Lx20"Wx10"D
Basin dimensions: 25"Lx18"Wx10"D

• FINISHES

Gold PVD Satin Brushed stainless steel

• INSTALLATION OPTIONS

Top-mount
Under-mount

• MINIMUM CABINET SIZE (I.D.)

Top-mount 28"
Under-mount 30"

• US DESIGN PATENT D618,324 S

• DUAL-MOUNT INSTALLATION

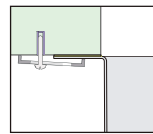

Under-mount

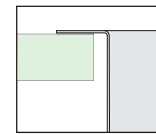

Top-mount

• ACCESSORY OPTIONS



MBG-085GDSB
Basin Grid



MCB-801BB
Cutting Board

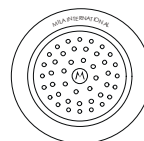

MKD-101GDSB
Strainer

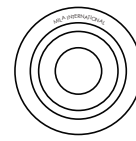

MDC-101GDSB
Disposal Collar

PROJECT INFORMATION			
Project			
Date	/	/	QTY
Specifier			
Contact			
Note			