

# ORION MOUS-502GPSB

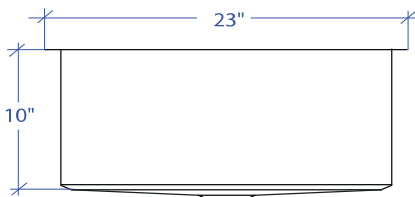

\*Custom ADA compliant versions are available

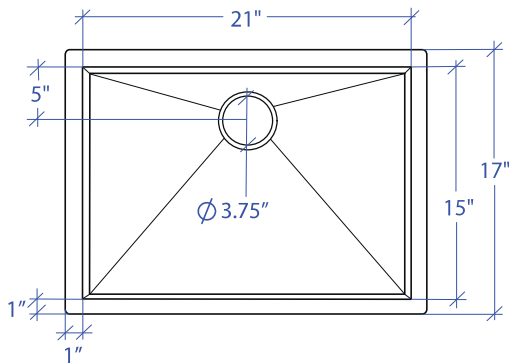

## • FEATURES

16-gauge type 304 stainless steel  
Bevel basin design

## • TECHNICAL INFORMATION

External dimension: 23"Lx17"Wx10"D  
Basin dimensions: 21"Lx15"Wx10"D

## • FINISHES

Graphite PVD Satin Brushed stainless steel

## • INSTALLATION OPTIONS

Top-mount  
Under-mount

## • MINIMUM CABINET SIZE (I.D.)

Top-mount 24"  
Under-mount 26"

## • US DESIGN PATENT D618,324 S

## • DUAL-MOUNT INSTALLATION

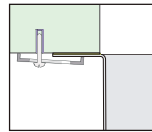

Under-mount

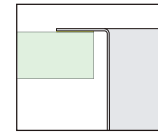

Top-mount

## • ACCESSORY OPTIONS

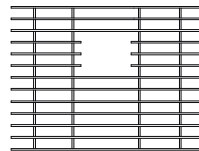

MBG-054GPSB  
Basin Grid

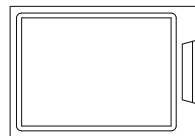

MCB-501BB  
Cutting Board

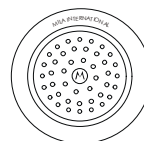

MKD-101GPSB  
Strainer

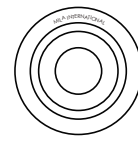

MDC-101GPSB  
Disposal Collar

### PROJECT INFORMATION

Project			
Date	/	/	QTY
Specifier			
Contact			
Note			