

## 9800 SERIES (1.25"/32mm)

### GRAB BAR

AVAILABLE IN: 12"/18"/24"/36"/42"

8289812/9818/9824/9836/9842

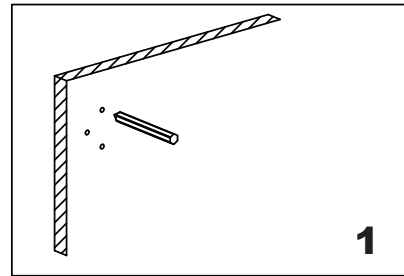
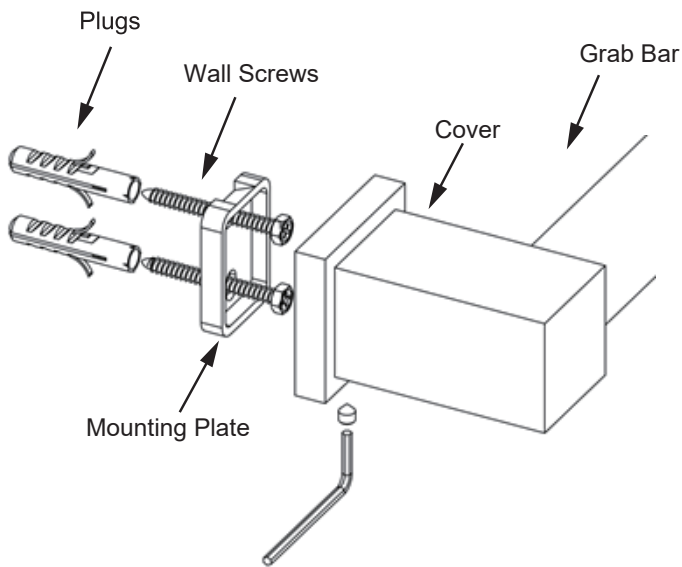

Mark (on the wall) locations of plugs through mounting plate using a pencil

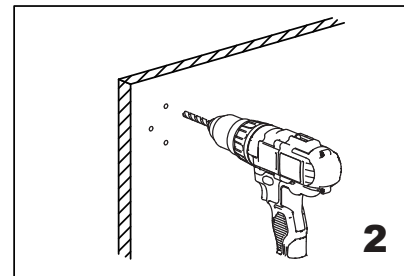

Drill 3/16" holes, make sure to keep drill level

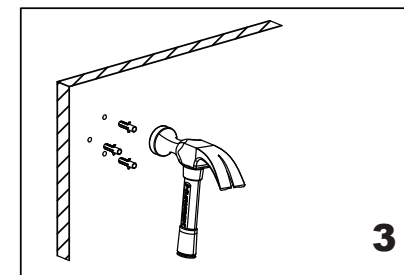

Insert plugs into drilled holes, using a hammer to tap the plugs in, be careful not to break tile

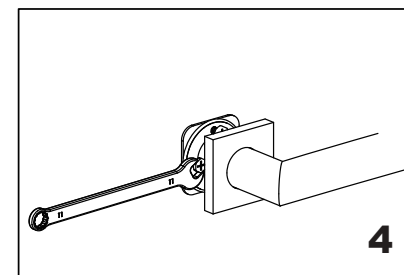

Driver bolt nut directly into holes

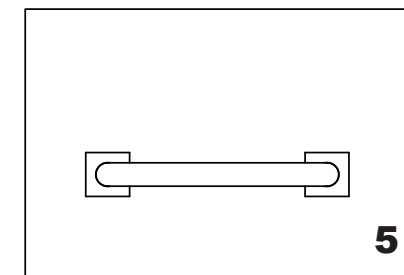

Tighten the cover on the Mounting plate

#### Tools required for installation

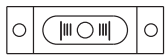

Level



Pencil



Wrench

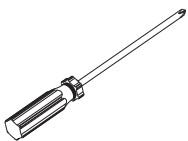

Screwdriver

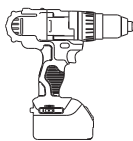

Drill

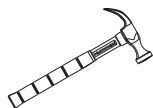

Hammer