

005460 | SMARTSTATION® SET

UNDERMOUNT REVEAL STAINLESS STEEL KITCHEN SINK AND ACCESSORIES

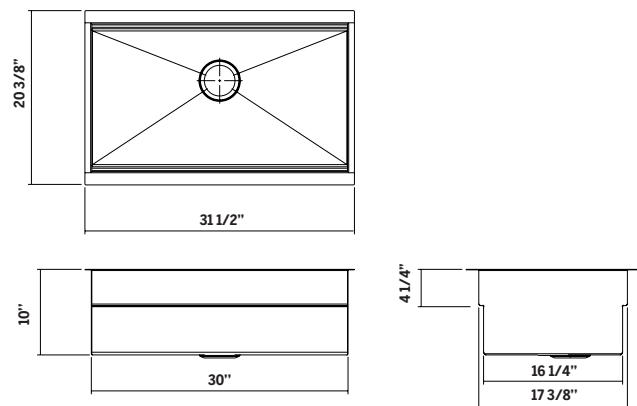

Specifications

Model	005460
Collection	SmartStation®
Bowl dimensions	30" x 17 3/8" x 10"
Overall dimensions	31 1/2" x 20 3/8" x 10"
Recommended cabinet	36"
Accessories handle material	Walnut

Included accessories

Grid	200909
Cutting board	210065
Serving bin with bowls (4)	225214
Serving board with bowl and colander	225207
Drying rack	215206

Recommended accessories

Drain	100082
Colander	205225
Service bowls	225203
And many more	

Warranty

Home Refinements offers a LIMITED LIFETIME WARRANTY on the fixed components of its stainless steel sinks against defects of material and workmanship as well as a 1-YEAR LIMITED WARRANTY following the purchase date for all accessories against defects of material and workmanship. This warranty is limited to defects or damages resulting from a normal residential use. For further details on our product warranty, please refer to our catalog or Web site.

Features

- Handcrafted in Canada
- Commercial quality stainless steel 16 ga thickness
- Corrosion resistant material 304 series (18/10)
- Unique design allowing the Home Refinements standard accessories to slide one over the other on two levels
- 1/2" accessory ledge on front and back of the bowl to accommodate any standard 16" Home Refinements accessory
- Standard 17" Home Refinements accessories to be used directly on the top edge (undermount with reveal countertop installation necessary)
- Many accessories included to be used on accessory ledge or on the top edge (two (2) wood essences available: maple and american walnut)
- Bottom grid included to protect the surface of the sink
- Attractive combination of UrbanEdge® and J7® collections : vertical square corners [0mm] and slightly rounded corners [7mm] for bottom front and back folds
- Environmentally friendly product, 100% recyclable
- Elegant no. 4 brushed finish that matches the appliances
- Highly efficient sound deadening pads
- Practical flat sink bottom and straight bowl sides that maximize available space in the bowl
- Stylish and functional bowl bottom grooves that facilitate water drainage
- Rear or side 3-1/2" drain placement
- Mounting hardware included
- Certifications: ASME A112.19.3, CSA B45.0, CSA B45.4