



Tuzio® Blenheim Towel Warmer Installation Guide

Code: H2023 / H2027
23.5" x 37" Hydronic

Technical Helpline:
Toll-Free 1-877-757-8990
www.icocanada.com



3005 Saskatchewan Drive
Regina, SK | S4T 1H5

toll-free | 1 877 757 8930
tel | 306 757 8941 fax | 306 757 8940

Congratulations!

You are the proud owner of a quality Tuzio Towel Warmer.

This product has been specifically engineered and tested to provide optimal comfort and satisfaction.

ICO carries a broad range of luxury bathroom products designed to make everyday living just a little more enjoyable! Visit www.icocanada.com to learn more.

Contents

Rough-In Requirements For Constant Circulation Heating System	Page 3
Rough-In Requirements For Dedicated Heating System	Page 4
Installation Instructions	Page 5
Valve Connection	Page 5
Specifications & Drawings – Wall Rough-In	Page 6
Specifications & Drawings – Floor Rough-In	Page 7

Towel Warmer Installation Procedure

① Rough-in Requirements - for constant circulation heating system (see figure 1)

Using this installation method, the towel warmer is controlled using the valves attached to the towel warmer, and can be operated independently from the heating system. This method of installation is popular where there are multiple heating appliances connected to a closed hot water heating system, and electronic control of the individual towel warmer is not important. Thermostatic valves are recommended in these installations. (see figure 5)

1. Install heating system pipework to proposed towel warmer location and tee off the main circuit to provide a branch circuit for the towel warmer. Piping to towel warmer valves should be 1/2" copper.
2. If towel warmer supply pipes are coming through wall, rough-in pipes as per locations shown on fig 4. If towel warmer supply pipes are coming through floor, rough-in pipes as per locations shown on fig 7.
3. If a hydronic installation pack is being used (see figs 5 & 8), these should be connected (solder connected) within the wall / floor. If a hydronic installation pack is not being used (see figs 6 & 9), these 1/2" copper supply lines should protrude through wall/floor in order to connect to towel warmer valves.
4. Wall studs or plywood backing is required in the wall at all bracket locations. See figure 4 for bracket locations.

fig. 1

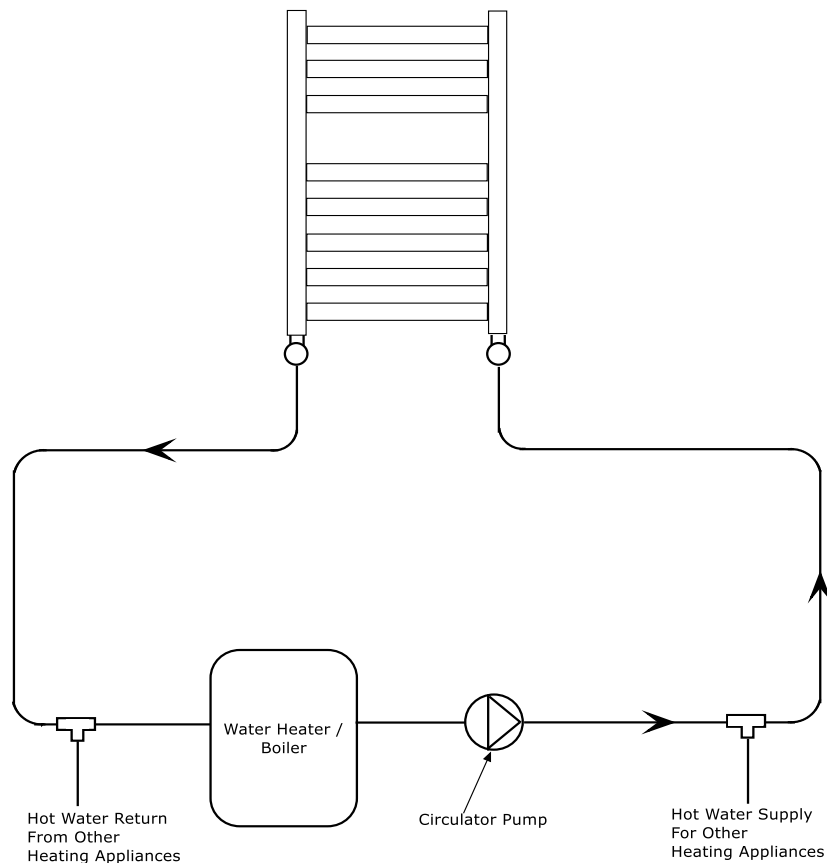

Towel Warmer Installation Procedure

① Rough-in Requirements - for dedicated heating system (see figure 2)

Using this installation method, the towel warmer is controlled using the thermostat wired to the circulator pump, and cannot be operated independently from the heating system. This method of installation is popular where there is only one heating appliance connected to a closed hot water heating system, and electronic control of the individual towel warmer is required.

1. Install heating system pipework to proposed towel warmer location. Piping to towel warmer valves should be 1/2" copper.
2. If towel warmer supply pipes are coming through wall, rough-in pipes as per locations shown on fig 4. If towel warmer supply pipes are coming through floor, rough-in pipes as per locations shown on fig 7.
3. If a hydronic installation pack is being used (see figs 5 & 8), these should be connected (solder connected) within the wall / floor. If a hydronic installation pack is not being used (see figs 6 & 9), these 1/2" copper supply lines should protrude through wall/floor in order to connect to towel warmer valves.
4. Wall studs or plywood backing is required in the wall at all bracket locations. See figure 4 for bracket locations.

fig. 2

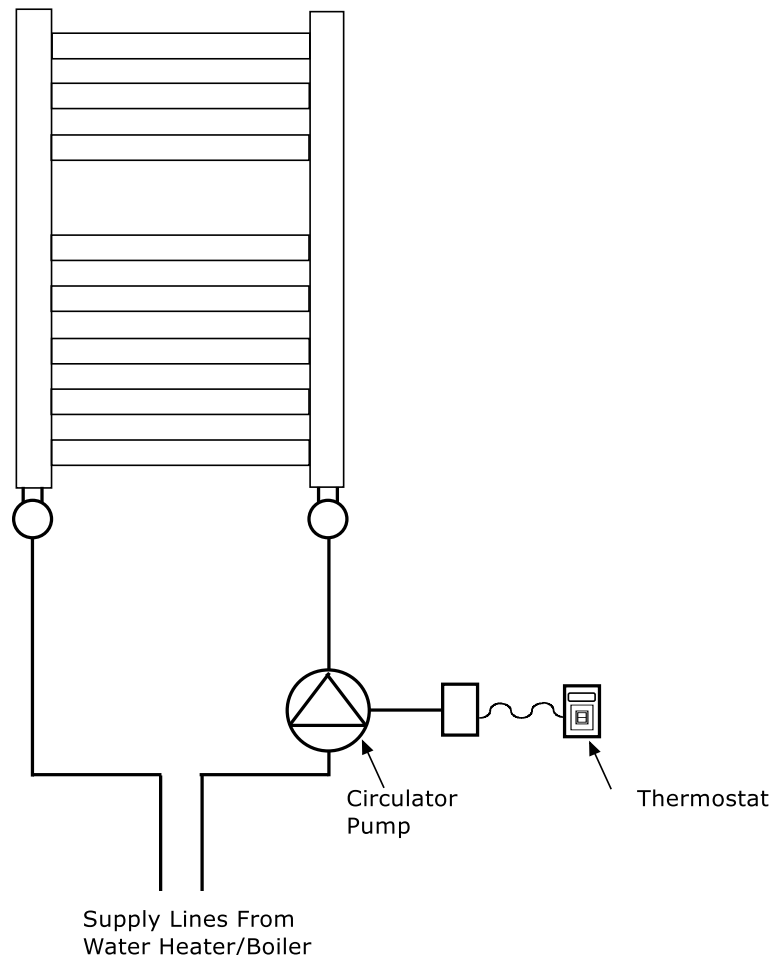

Towel Warmer Installation Procedure

2 Installation Instructions (see figure 3)

1. Check all items have been received. These should include Towel Warmer and mounting bracket kit. Read all instructions before continuing.
2. Fix wall supports "A" to the wall using the screws provided and in locations as shown on figure 4 on page 6.
3. Assemble the threaded pin "B", the washer "C", the bush "D" with the threaded head "E", between the second and third upper and lower tubes of the Towel Warmer.
4. Hang and adjust the Towel Warmer using set screws "F" to lock pin "B" in the wall bracket "A". Ensure the Towel Warmer is firmly and safely fixed.

fig. 3

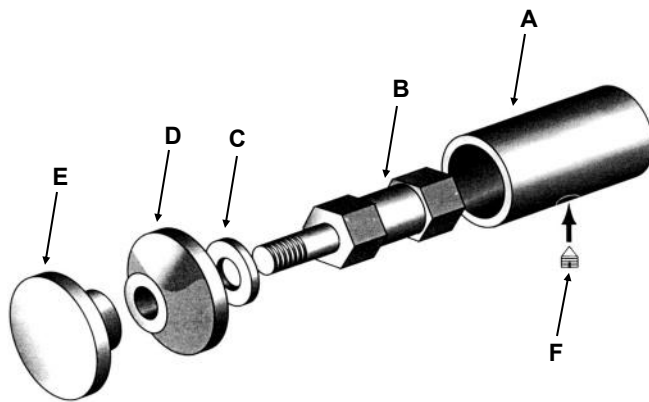

3 Valve Connection (see figure 5, 6, 8 or 9)

1. If using a hydronic installation pack, slide escutcheon (supplied with hydronic installation pack) over 1/2" supply pipe.
2. Unscrew male threaded components including collars from valve and thread into female inlets at bottom of towel warmer using a 12mm allen key wrench.
3. Push compression fitting on to 1/2" supply pipe and tighten 1/2" compression fitting collar on valve.
4. Seat male threaded component (now connected to towel warmer) on valve and tighten collar.
5. Insert blank plug and air vent plug (supplied with bracket kit) into top female inlets on towel warmer.
6. Check for leaks and bleed system if necessary using air vent plug.

Warning: All hydronic plumbing connections should be made in accordance with local and national plumbing regulations. It is the responsibility of the plumber to ensure plumbing system and towel warmer installation comply with these regulations.

Specifications & Drawings (wall rough-in)



Model #	Description	Finish	Weight (lb)	Output	WxH (mm)	WxH (Inches)	Metal Type
H2023	Blenheim Hydronic	Chrome	22.0	2532Btu	600 x 940	23.5" x 37"	Mild Steel
H2027	Blenheim Hydronic	OR Bronze	22.0	2532Btu	600 x 940	23.5" x 37"	Mild Steel
A1043	Thermostatic Angle Valve	Chrome	2.0	-	-	-	Brass
A1017	Regular Angle Valve	OR Bronze	2.0	-	-	-	Brass
A3013	8" Installation Pack	Chrome	0.4	-	-	-	Copper
A3017	8" Installation Pack	OR Bronze	0.4	-	-	-	Copper

Material Specifications: Mild Steel - Din 2394 Quality - ST 34-2 KB

Warranty: 5 years

Fixings: Screws and fixings are included

Hydronic System: Hydronic towel warmer should be used only on a closed system incorporating an anti-rust inhibitor.

Care & Maintenance: A periodic wash using warm water and a soft cloth will retain the high quality finish of your towel warmer for many years to come. ON NO ACCOUNT should any household bleaches, detergents, abrasive polishes, steel wool or other cleaning agents be used on this item.

IMPORTANT: Circuit temperature must not exceed 158° Fahrenheit.

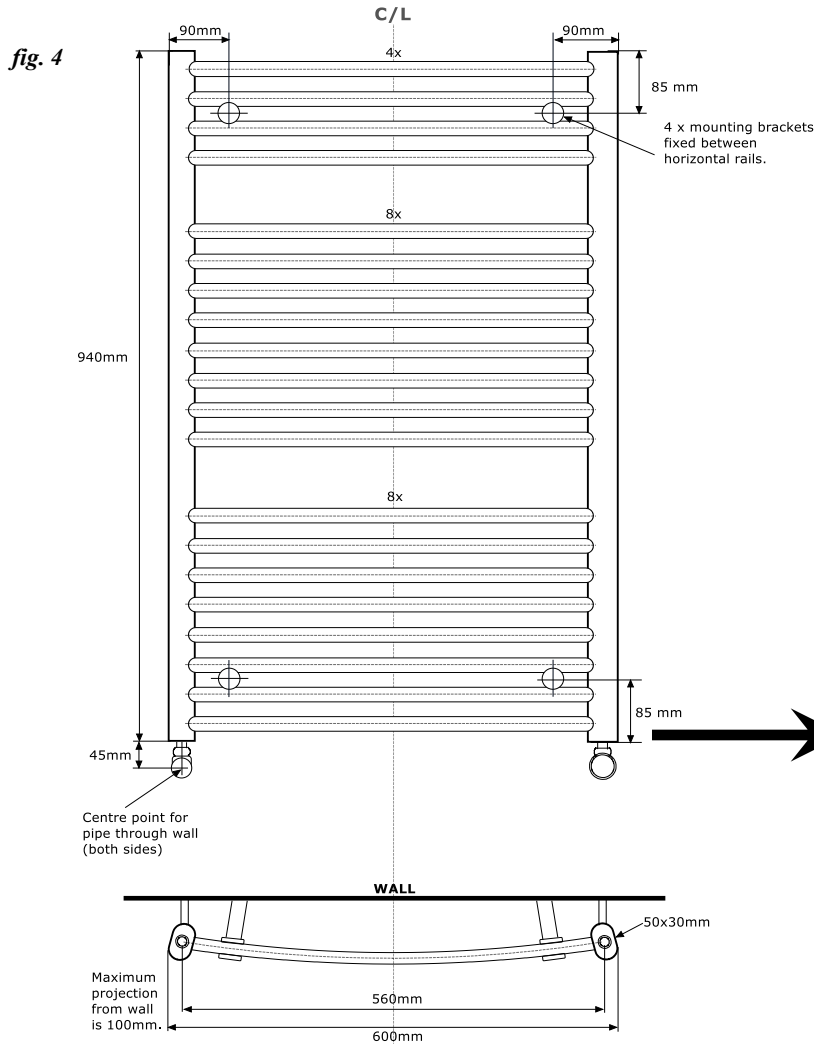

Specifications & Drawings (floor rough-in)



Model #	Description	Finish	Weight (lb)	Output	WxH (mm)	WxH (Inches)	Metal Type
H2023	Blenheim Hydronic	Chrome	22.0	2532Btu	600 x 940	23.5" x 37"	Mild Steel
H2027	Blenheim Hydronic	OR Bronze	22.0	2532Btu	600 x 940	23.5" x 37"	Mild Steel
A1053	Thermostatic Straight Valve	Chrome	2.0	-	-	-	Brass
A1027	Regular Straight Valve	OR Bronze	2.0	-	-	-	Brass
A3103	24" Installation Pack	Chrome	1.0	-	-	-	Copper
A3107	24" Installation Pack	OR Bronze	1.0	-	-	-	Copper

Material Specifications: Mild Steel - Din 2394 Quality - ST 34-2 KB

Warranty: 5 years

Fixings: Screws and fixings are included

Hydronic System: Hydronic towel warmer should be used only on a closed system incorporating an anti-rust inhibitor.

Care & Maintenance: A periodic wash using warm water and a soft cloth will retain the high quality finish of your towel warmer for many years to come. ON NO ACCOUNT should any household bleaches, detergents, abrasive polishes, steel wool or other cleaning agents be used on this item.

IMPORTANT: Circuit temperature must not exceed 158° Fahrenheit.

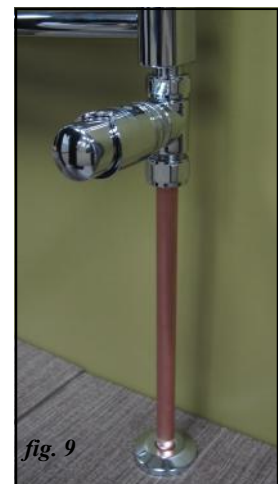
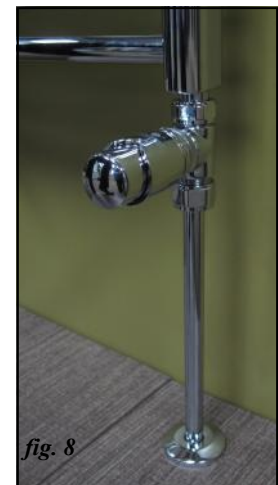
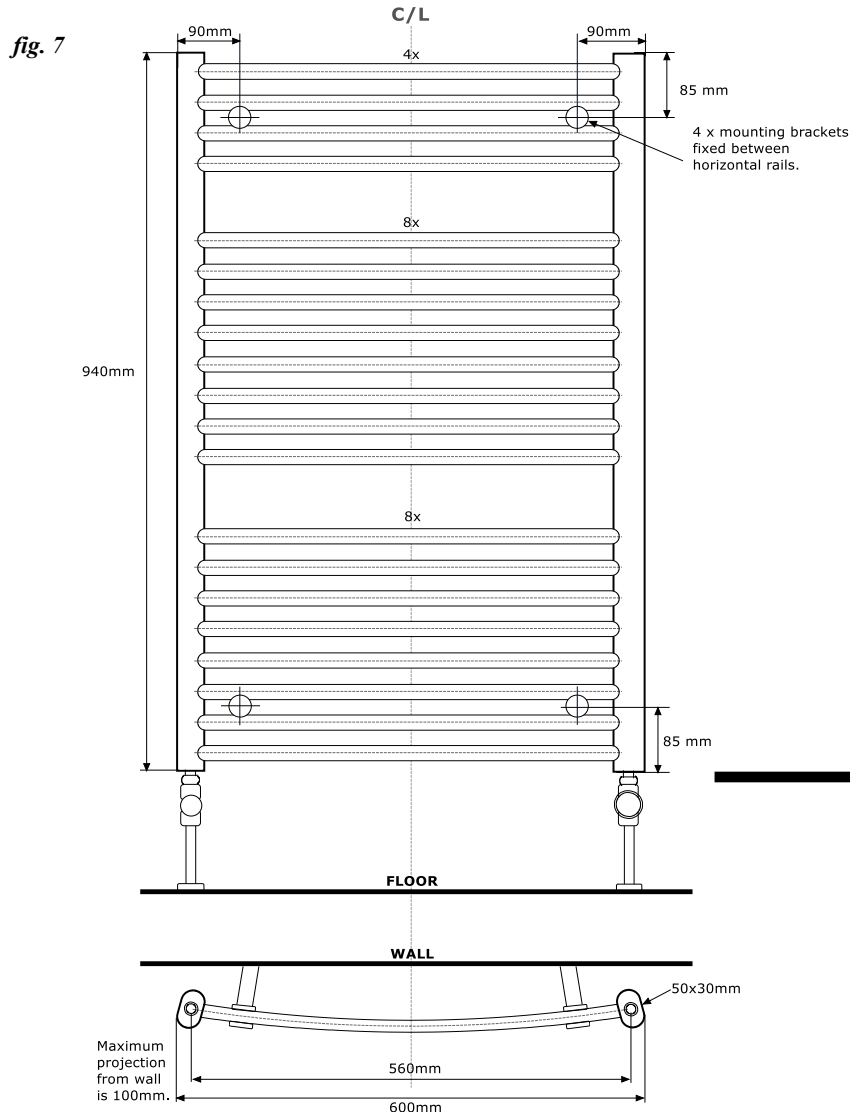

Tuzio®

OSY®
BOARD

OSY®
FLOOR



Towel Warmers



Electric In-Floor Heating



Insulation Board



Bathroom Luxury

info@icocanada.com
www.icocanada.com

toll-free | 1 877 757 8930
tel | 306 757 8941 fax | 306 757 8940

3005 Saskatchewan Drive
Regina, SK | Canada | S4T 1H5