

Sink Leonardo Gold 20" x 20" – U/M - 1013 669

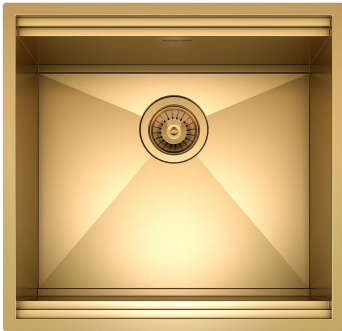

Sinks

Code: 1013 669

AISI 304 Stainless steel

Satin finish

Undermount

x cross bending for easy water draining



DETAILS

Series Leonardo

Coloring Gold

Finish Satin finish

Finish PVD

Material AISI 304 stainless steel

Thickness 16 Gauge (1.5 mm)

Inset type Undermount

Overall dimensions 19 11/16" 19 19/64"

Bowls dimensions	1 bowl 18 ³ / ₁₆ " x 15 ³ / ₄ "
Bowls depht	10 "
Cut out	18 ³ / ₁₆ " x 17 ⁵ / ₆₄ "
Waste fitting type	3 ¹ / ₂ " - with stainless steel basket
Bowls bottom	X cross bending for easy water draining
Underside	Protected with heavy duty undercoating
Fixing system	Undermount fixing kit (brass insert and clips)

FEATURES

Diamond-shape bottom	The draining of water is an important feature in a sink, and it's always taken good care of in Foster products. In the bent-welded sinks, which would have a flat bottom, the proper draining is guaranteed by the elegant beveling, which helps the water flow.
High thickness	1.5 mm thick steel. A significant thickness, which guarantees the maximum sturdiness and durability.
Basket 3,5" waste fitting	The drain is equipped with a large 3.5" drain, with the practical basket cap that prevents the discharge of solid parts. The 3.5 "drain allows the use of the Foster waste-disposer, compatible with all models.
Triple recess - sliding accessories	The Foster Milano sink has an ingenious design that makes it simple to use a large set of optional accessories. On the topmost supporting step, the innovative Black grids slide, creating a large and practical surface to rinse food and crockery. The second step is meant to support and allow the sliding of a complete combination of accessories, which make some operations practical and safe: rinse, drain, slice, grate... everything can be done inside the sink. The third supporting step is on the bottom of the bowl. On this step one can rest the Black grids, making it possible to rinse foodstuffs without their coming in contact with the bottom of the sink, which may be dirty.

TECHNICAL DATA

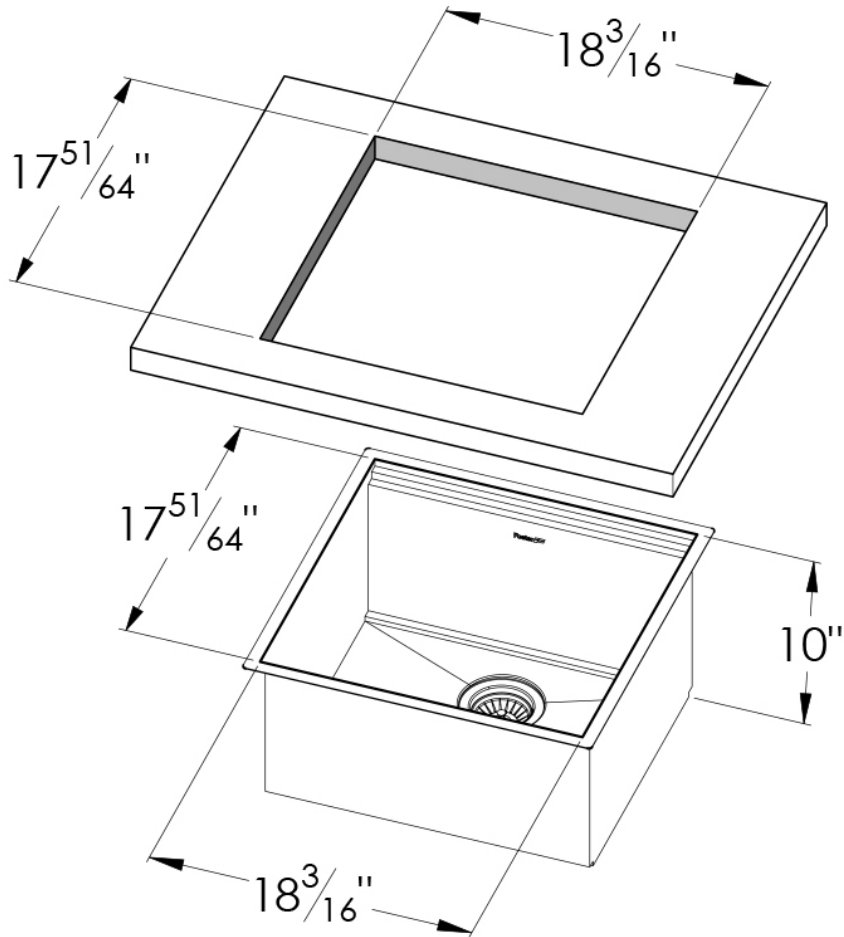

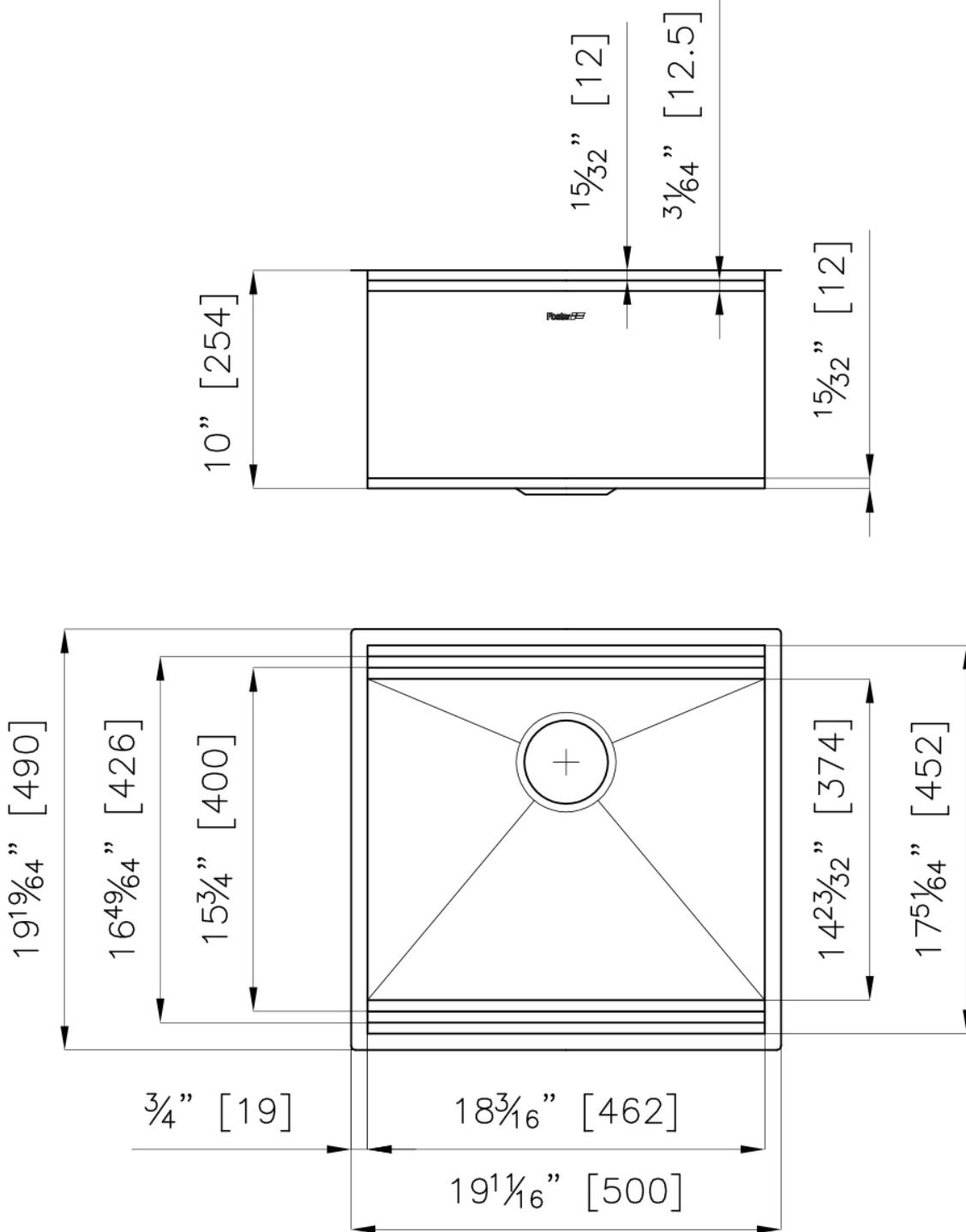

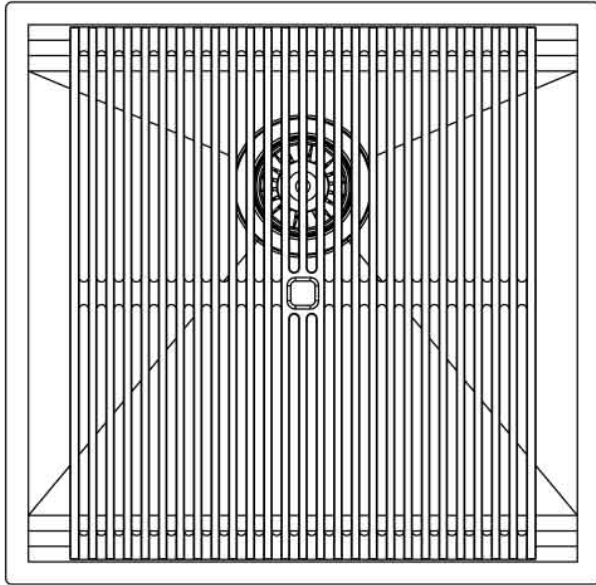

8100 600

Edge positioning

8100 600

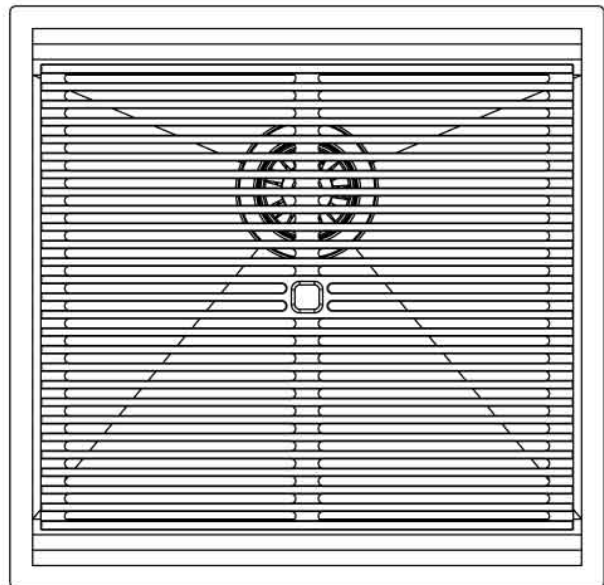

Bottom positioning

OPTIONAL ACCESSORIES



3 Bottles-holder set 8100 621



3 Bowls set 8100 622



4 Spices-holder set 8100 620



Black Grid 8100 600



Chopping Board - 8642 000



Chopping Board 8631 300



Grating kit complete with ring support and food collection tray 8159 101

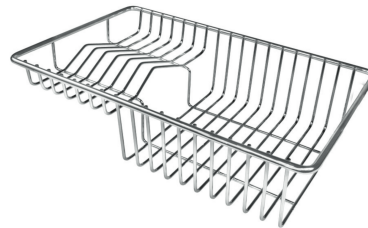

Stainless Steel dishes holder 8100 303



Stainless steel perforated pan 8151 000



Twin Chopping Board - 8644 101



White bowl 8153 100

WARNING:

The accessories 8159101, 8100303, 8151000 are only usable in combination with 8644101

RECOMMENDED PAIRINGS



Faucet Capri Gold - 8467 905

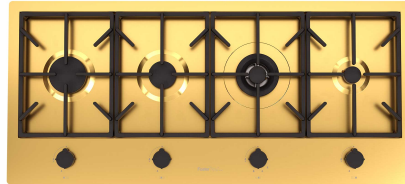

Milano Cooktop Gold 4 burners
inLine - 7640 909

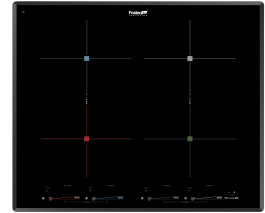

Milano Induction Cooktop 4 Plate
- 7371 945