

NEREA PLUS - FV210/59V

Deck mounted Roman bath faucet 3/4" valves with knurled handles vertical styles
 Juego para hidromasaje con volantes moleteados estilo vertical

FRANZ
VIEGENER

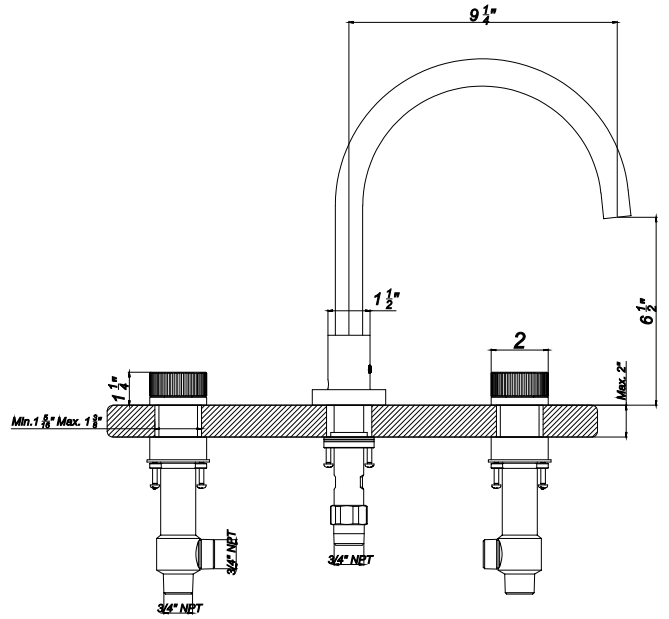

FEATURES

CARACTERÍSTICAS

- All brass construction.
Producto realizado íntegramente en latón.
- Brass valve bodies.
Cuerpos de válvulas fabricados en latón.
- Quarter-turn ceramic cartridges.
Cartuchos cerámicos de 1/4 de giro.
- Stationary spout with recessed aerator device.
Pico con aireador oculto.
- Flexible SS connectors with sediment screens.
Flexibles con conectores SS y filtro de sedimento.









FLOW RATE

CAUDAL

- Maximum flow rate 4.9 gpm (18,6 l/min) at 20 PSI (1,4 kg/cm²)
Caudal máximo 4.9 gpm (18,6 l/min) tomado a 20 PSI (1,4 kg/cm²)

COLOR / FINISHES

COLOR / ACABADOS

- | | | |
|---|---|---|
|  PC
Polished Chrome. |  PN
Polished Nickel. |  BN
Brushed Nickel. |
|  BG
Brushed Gold. |  PG
Polished Gold. |  RG
Rose Gold. |
|  BK
Black Chrome. |  FB
Flat Black. |  UPB
Unlacked Polished Brass |

ITEM DETAILS

DETALLE DE PRODUCTO

COMPLIANCE

CERTIFICACIONES

