

PDR48

PANIC DEVICE 45" / RIM MOUNT / COLD ROLL STEEL



DRAWING NOT TO SCALE

NOTE: Deltana reserves the right to constantly improve its products and is not responsible for differences between the product in-hand and the specifications contained in this drawing. We do not recommend to pre-drill holes or pre-cut woods or metals based on the drawing information if the veracity of the specifications has not been proven by the live product.

PDR48

PANIC DEVICE 45" / RIM MOUNT / COLD ROLL STEEL

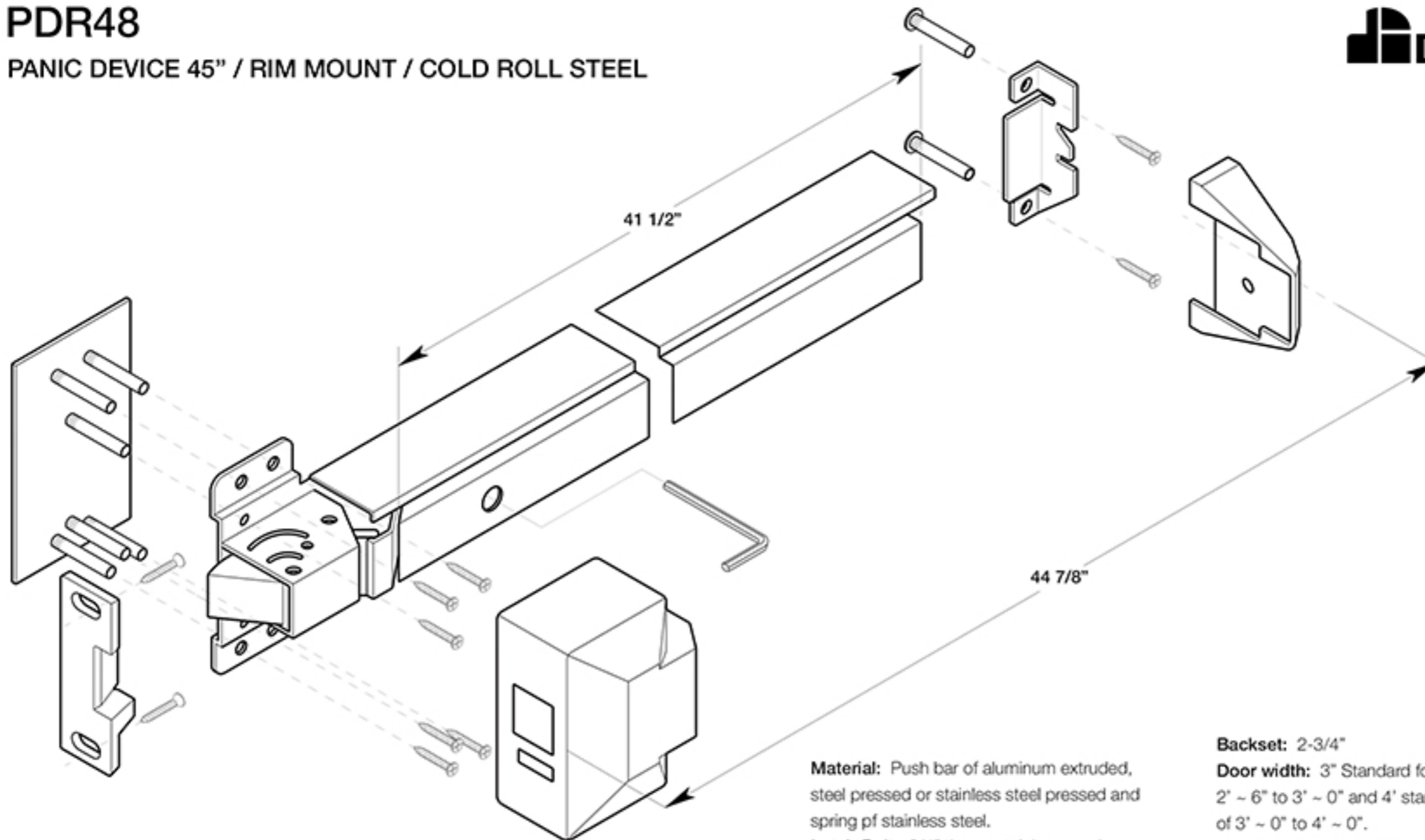

Material: Push bar of aluminum extruded, steel pressed or stainless steel pressed and spring pf stainless steel.
Latch Bolt: 3/4" throw, stainless steel.
Dead Latch Bolt: 5/8" stainless steel.
Strike: For 5/8" stop, plus shim for 1/2" stop.
Proyection: 2-1/2" maximum, 1-7/8" pressed.
Reversible: Non-handed, reversible for all functions and trims.
For Door: 1-3/4" thick standard. Specify if other than 1-3/4".
Dogging: 1-4" turn hex key dogging.

Backset: 2-3/4"
Door width: 3" Standard for door widths of 2' - 6" to 3' - 0" and 4" standard for door widths of 3' - 0" to 4' - 0".
Mounting height: 40-5/16" from CL to finished floor recommended.
Mounting: Furnished standard with metal sheet & machine screw or SNB as option.
Cylinders: For trim, knob, lever and thumb-press type, Schlage C" keyway.
Operation: Inside be slight pressure on any point of the push bar at all time.
Models: Rim type and Vertical rod type available.

DRAWING NOT TO SCALE

NOTE: Deltana reserves the right to constantly improve its products and is not responsible for differences between the product in-hand and the specifications contained in this drawing. We do not recommend to pre-drill holes or pre-cut woods or metals based on the drawing information if the veracity of the specifications has not been proven by the live product.