

STYLE × FONCTION

Description

- Valve de douche pression équilibrée
- Valve à contrôle de débit
- *Pressure balanced shower control valve*
- *Volume control valve*

Débit / Flow rate

- 23 l/min - 60 psi
- 6 gpm - 60 psi

Cartouche / Cartridge

- CAR-1020-40

Finis disponibles / Available finishes

- CC: Chrome / *Chrome*
- NN: Nickel / *Nickel*
- GG: Or / *Gold*
- **: Fini spécial / *Special finish*



Inclus / Included

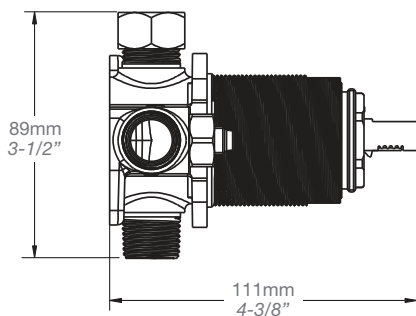

RVA-9020-00-B

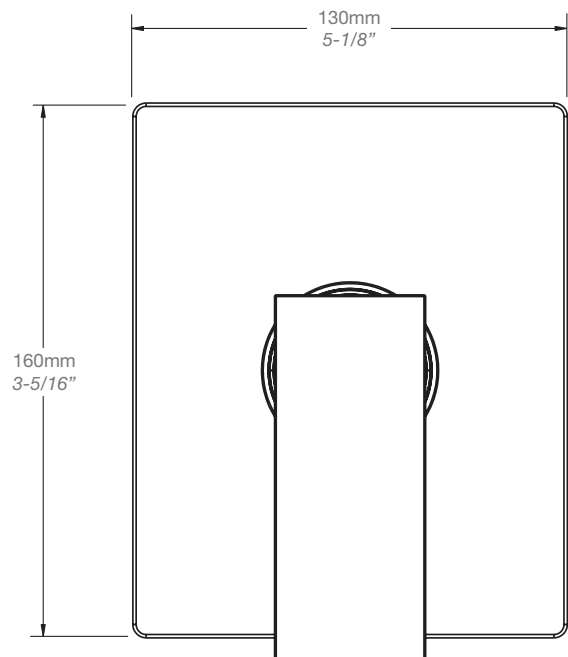

T95-9139-00-xx